

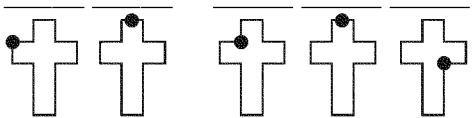

Jesus prayed to God to “sanctify” His disciples.
What does that mean?

Use the cross code to find the answer. P O E

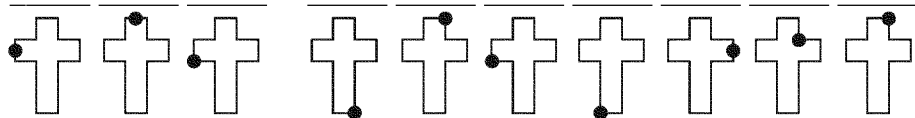
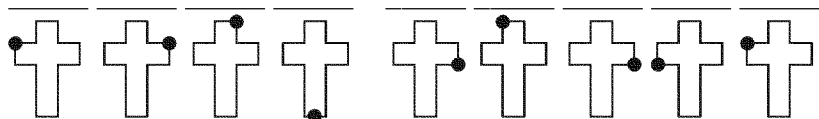
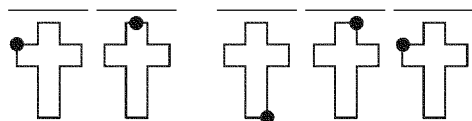
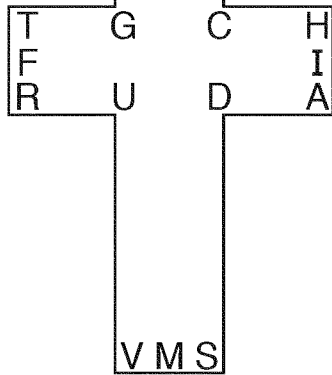
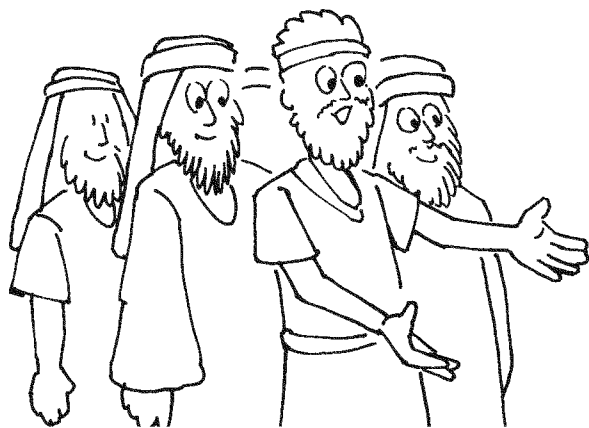

Children's Worship Bulletin™

Ages 7+

May 12, 2024 • John 17:6-19

Jesus Prays for His Disciples

Jesus prayed to God for His disciples.
What did He say?

Fit the vowels into the words in the order given.
I a o a i o e o u o o e o u a e i e e o e a e o u

“ ___ ___ m ___ n ___ t
 pr ___ y ___ ng f ___ r
 th ___ w ___ rld,
 b ___ t f ___ r th ___ s ___
 Y ___ ___ h ___ v ___
 g ___ v ___ n M ___,
 f ___ r th ___ y
 ___ r ___ Y ___ ___ rs.”



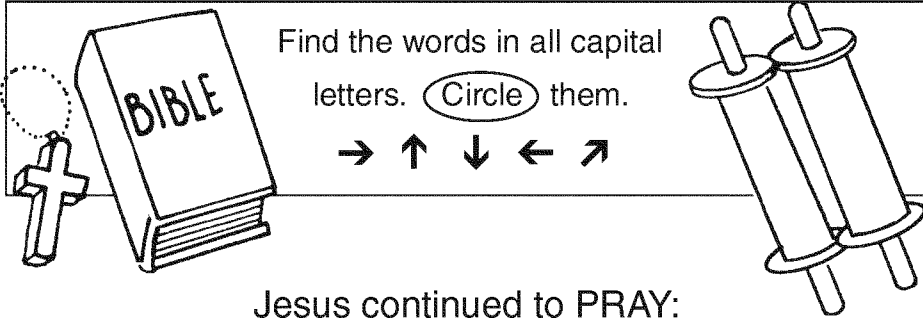

Jesus continued to PRAY:

“ALL I have is YOURS, and all You have is MINE.
 And GLORY has come to Me through them. I will
 REMAIN in the WORLD no longer. ... While I was with
 them, I ... KEPT them SAFE by that NAME You gave
 Me. ... I say these things ... so that they may have ...
 My JOY in them.”

B	C	W	O	R	L	D	A	L	L	G
E	V	E	R	Y	T	H	I	N	G	L
L	D	R	O	W	B	T	R	Y	T	O
I	O	N	E	T	C	R	J	O	Y	R
E	N	A	M	E	A	U	N	U	V	Y
V	O	N	T	D	S	T	Q	R	P	P
E	P	O	W	E	R	H	N	S	R	S
D	R	E	M	A	I	N	C	T	A	A
P	B	S	A	N	C	T	I	F	Y	F
A	C	C	E	P	T	E	D	N	V	E
M	I	N	E	K	E	P	T	N	O	W



How many other words from John 17 can you find in the word search?

Jesus asked God to do something for His disciples.
 Solve the puzzle to learn what He asked.



Answer each statement, True or False.
 Circle the letter in the correct answer column.
 Write each circled letter on the numbered lines below.

	True	False
1. Jesus appeared to His disciples after His resurrection.	E	M
2. John the Baptist came before Jesus.	T	E
3. Jesus took the disciples to pray in Central Park.	C	O
4. Some of Jesus' disciples had been fishermen before.	R	A
5. Jesus prepared His disciples to go into the world to gather people to God.	C	L
6. Jesus had 12 chosen disciples.	P	B
7. The disciple who betrayed Jesus was named Abraham.	S	T

To _____ them.
 6 4 3 7 1 5 2